

## Den lille Rødhætte / Little Red Riding Hood / 小红帽

Kan du skrive titlen "Den Lille Rødhætte" på et andet sprog?



## Tal til tal

Forbind tallene fra 1-5 på de forskellige sprog.  
Farvelæg tegningen bagefter.

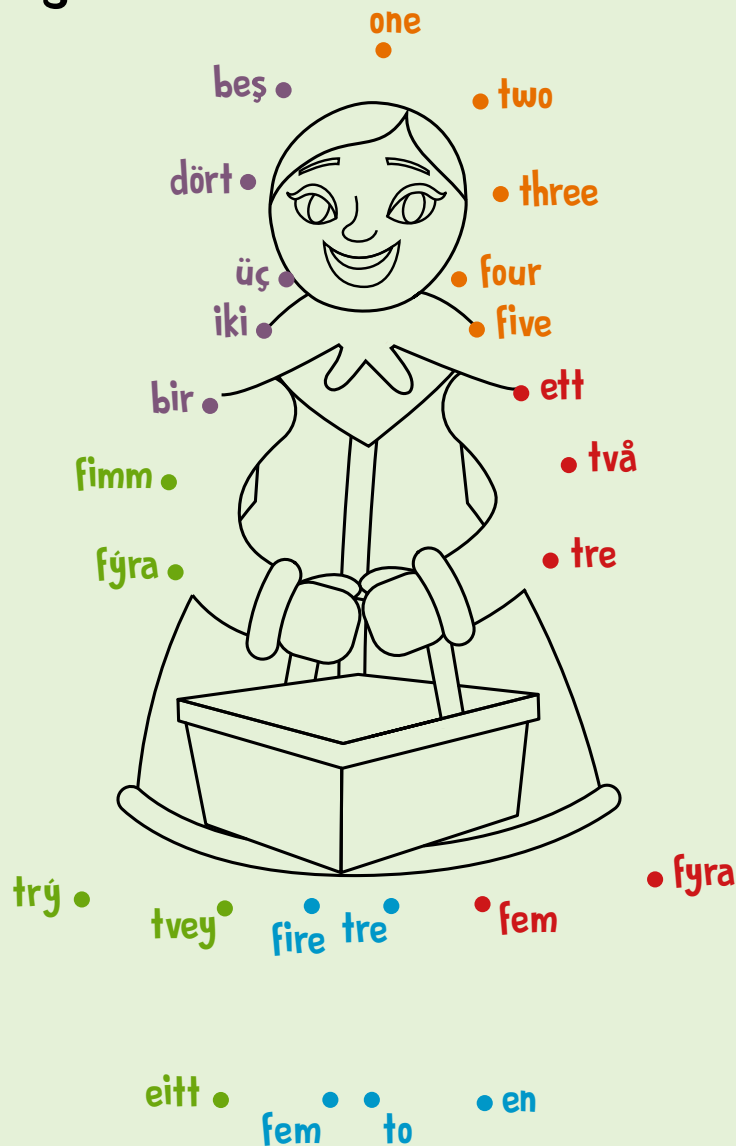

Mit navn / My name:























---

Den lille Rødhætte / Little Red Riding Hood / 小红帽

Kan du skrive titlen "Den Lille Rødhætte" på et andet sprog?



# Det hieroglyfiske alfabet

	<b>A</b>		<b>I</b>		<b>Q</b>
	<b>B</b>		<b>J</b>		<b>R</b>
Brug 'K' eller 'S' afhængigt af lyd	<b>C</b>		<b>K</b>		<b>S</b>
	<b>D</b>		<b>L</b>		<b>T</b>
	<b>E</b>		<b>M</b>		<b>U, V, W</b>
	<b>F</b>		<b>N</b>		<b>X</b>
	<b>G</b>		<b>O</b>		<b>Y</b>
	<b>H</b>		<b>P</b>		<b>Z</b>

Mit navn / My name:

---

Den lille Rødhætte / Little Red Riding Hood / 小红帽



# Vendespil med farver



rød

red

whero

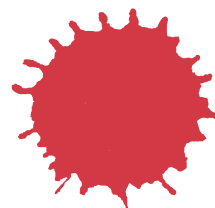
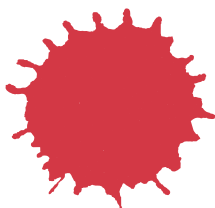
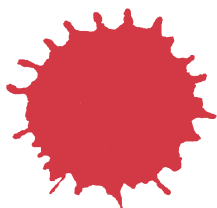

grøn

green

kākāriki

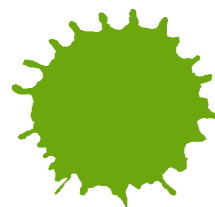
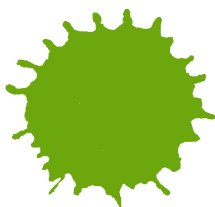
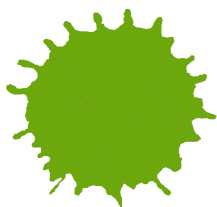

Mit navn / My name:

---

Den lille Rødhætte / Little Red Riding Hood / 小红帽



# Vendespil med farver



blå

blue

kikorangi

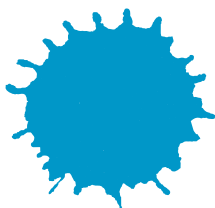
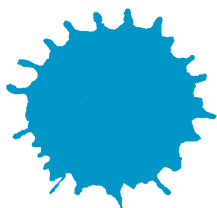

gul

yellow

kowhai

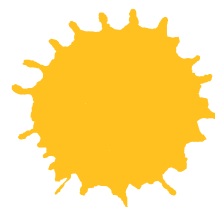
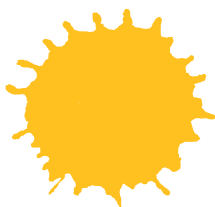
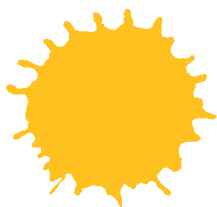

Mit navn / My name:

---

Den lille Rødhætte / Little Red Riding Hood / 小红帽



# Vendespil med farver



sort

black

pango/  
mangu

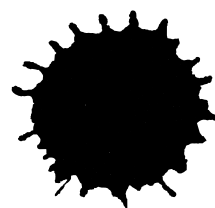
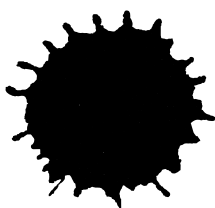
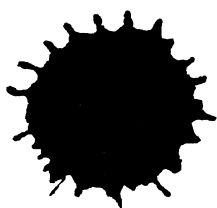

hvid

white

mā

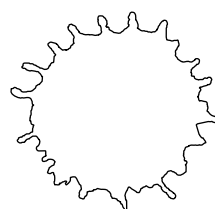
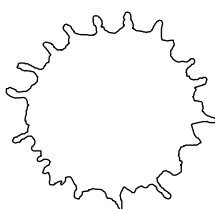
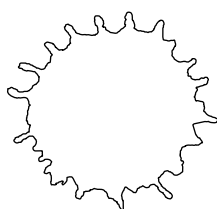

Mit navn / My name:



---

Den lille Rødhætte / Little Red Riding Hood / 小红帽



# Vendespil med farver

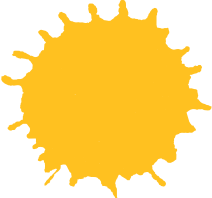
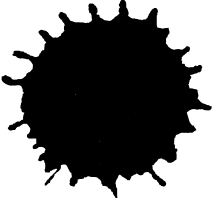
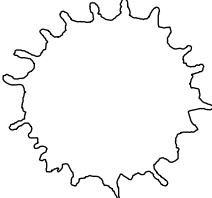

Mit navn / My name:

---

# Den lille Rødhætte / Little Red Riding Hood / 小红帽

Kan du skrive titlen "Den Lille Rødhætte" på et andet sprog?



## Billedhistorie



Mit navn / My name:

---

Den lille Rødhætte / Little Red Riding Hood / 小红帽

Kan du skrive titlen "Den Lille Rødhætte" på et andet sprog?



# Rødhættes kurv

Skriv og tegn det, som Rødhætte har i kurven på de forskellige sprog.

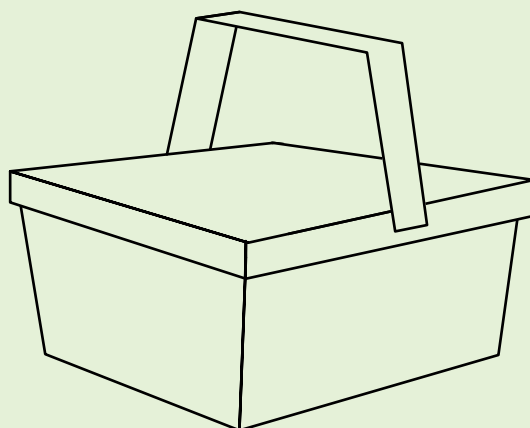
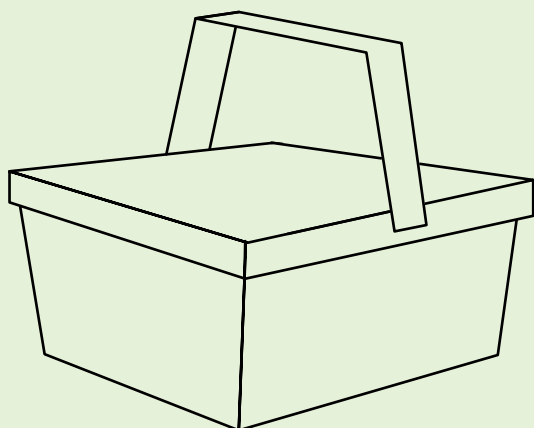
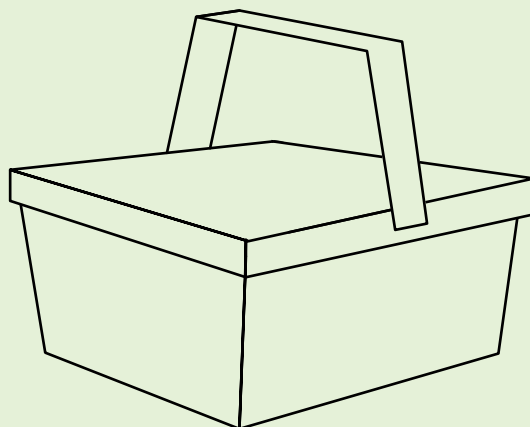
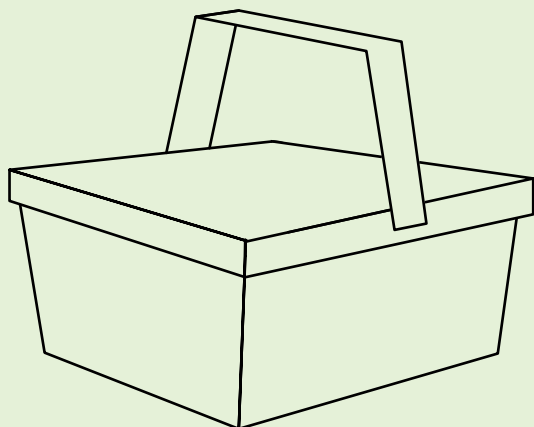

Mit navn / My name:

---